

**Muster**  
**Echantillons**  
**Samples**

# **Webnet Evo**

Musterrahmen

Display frame

Cadre d'échantillon

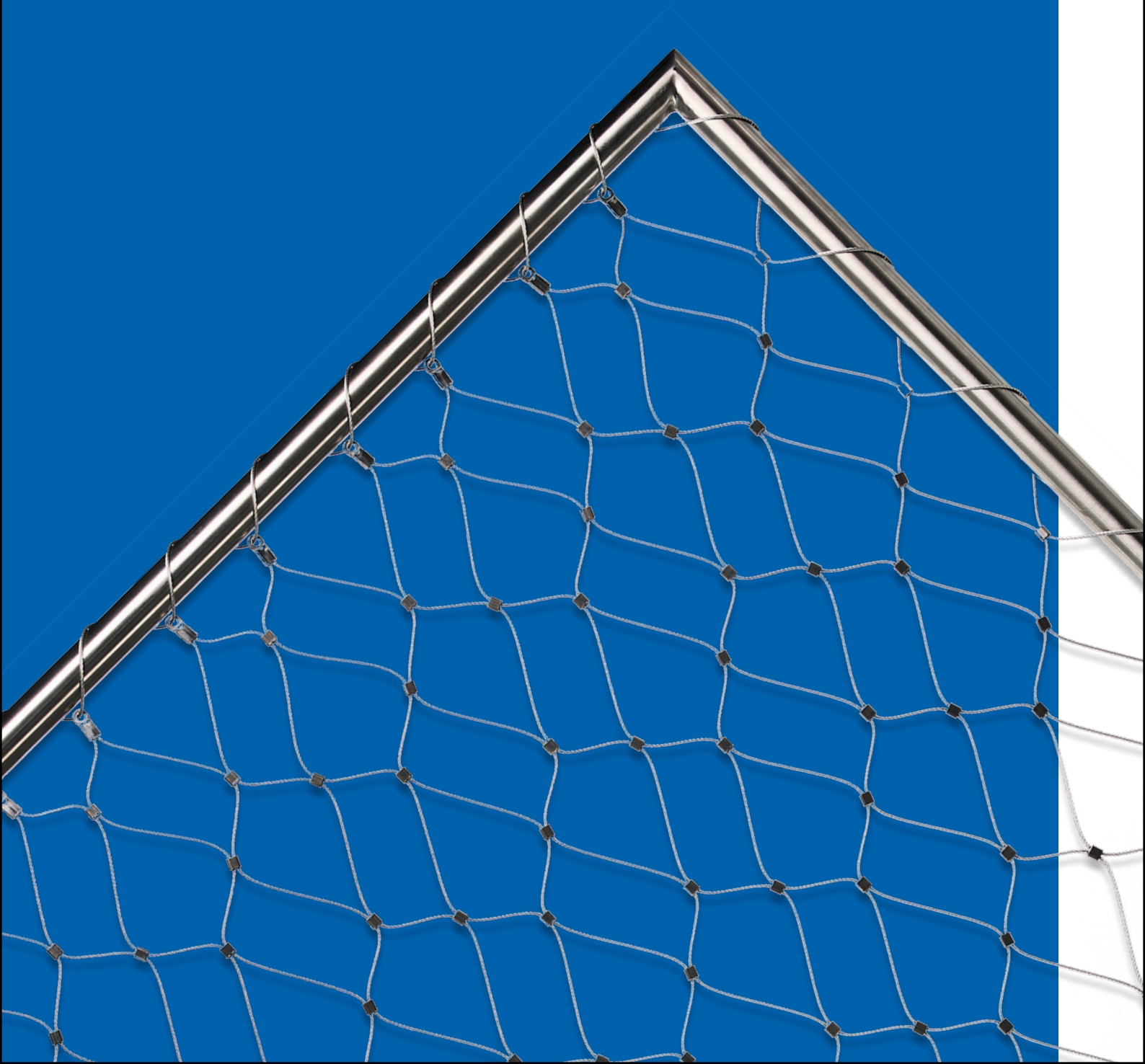

# Webnet Evo

Musterrahmen / Display frame / Cadre d'échantillon

Rundrohr / Tubes rond / Round tube:  $\varnothing$  26,9 mm

Seil / Cable / Rope:  $\varnothing$  2mm

Rohrrahmen H x L / Cadre en tubes H x L / Tube frame H x L: 750 x 1000 mm

Werkstoffgruppe AISI 316  
Group de matériaux AISI 316  
AISI 316 material group

**Muster**  
**Echantillons**  
**Samples**  
Version: 03.08.2022

| Nr./N°/No.    | Typ<br>Type<br>Type | W1 x H1<br>ca. mm | Maschenweite<br>Dimension de maille<br>Mesh aperture<br>W2 x H2<br>ca. mm | Gewicht<br>Poids<br>Weight | Netto-Einheitspreis<br>Prix unitaire net<br>Net unit price |       |       |
|---------------|---------------------|-------------------|---|----------------------------|--|-------|-------|
|               |                     |                   |   |                            | CHF  | EUR   | USD   |
| 22263-0200-11 | 1-a                 | 68 x 145          | - x -   | 6,30                       | 150.-  | 150.- | 150.- |
| 22263-0200-12 | 1-b                 | 83 x 170          | - x -   | 6,30                       |  |       |       |
| 22263-0200-21 | 2-a                 | 73 x 112          | 55 x 88   | 6,30                       |  |       |       |
| 22263-0200-22 | 2-b                 | 88 x 159          | 66 x 127  | 6,30                       |  |       |       |
| 22263-0200-31 | 3-a                 | 73 x 109          | 73 x 109  | 6,30                       |  |       |       |
| 22263-0200-32 | 3-b                 | 98 x 150          | 98 x 150  | 6,30                       |  |       |       |
| 22263-0200-41 | 4-a                 | 50 x 92           | 50 x 121  | 6,30                       |  |       |       |
| 22263-0200-42 | 4-b                 | 70 x 124          | 70 x 164  | 6,30                       |  |       |       |
| 22263-0200-51 | 5-a                 | 75 x 109          | - x 148   | 6,30                       |  |       |       |
| 22263-0200-52 | 5-b                 | 90 x 130          | - x 180   | 6,30                       |  |       |       |

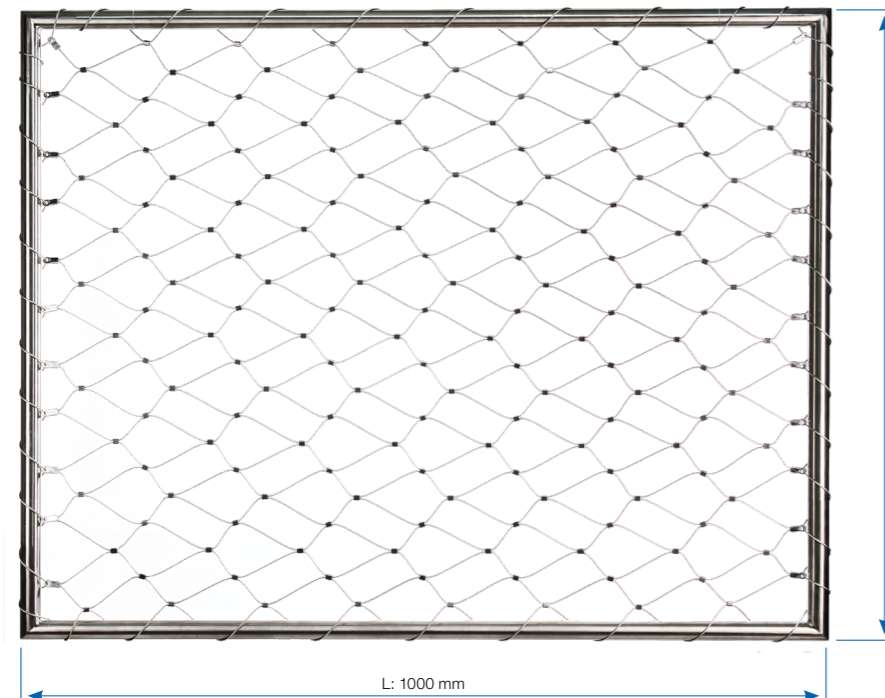

H: 750 mm

L: 1000 mm

Typ/Type 1

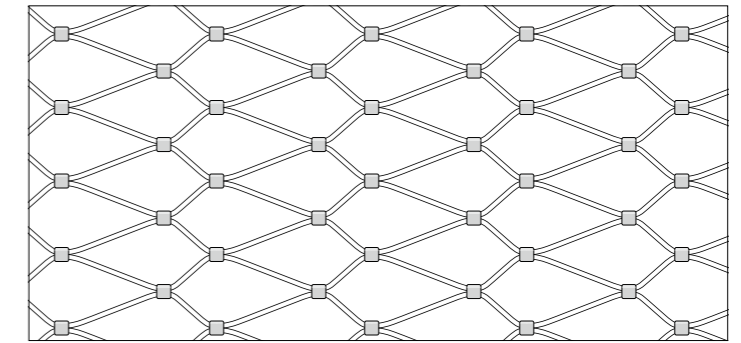
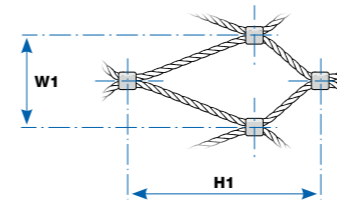

Typ/Type 2

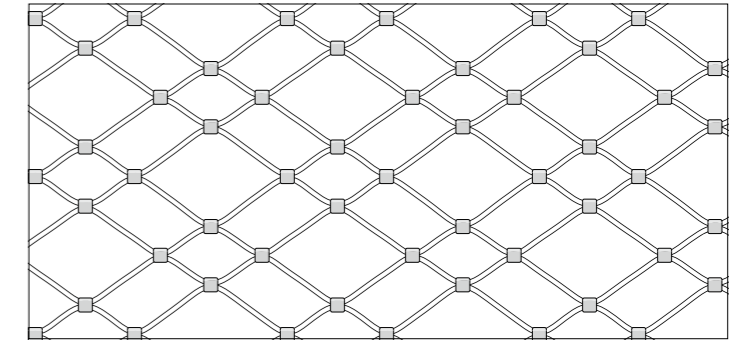
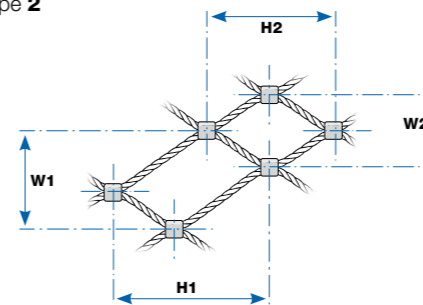

Typ/Type 3

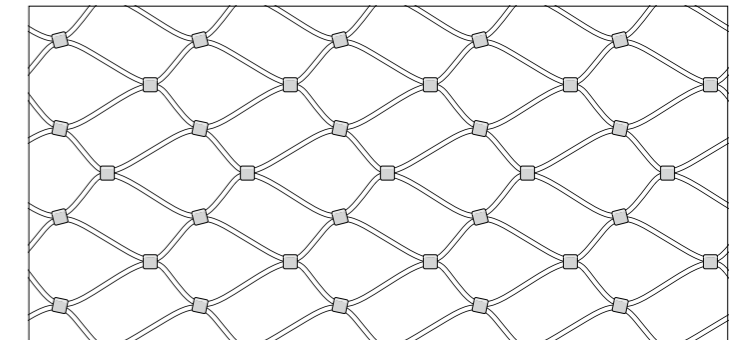
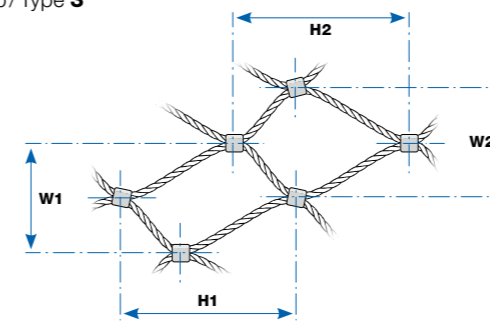

Typ/Type 4

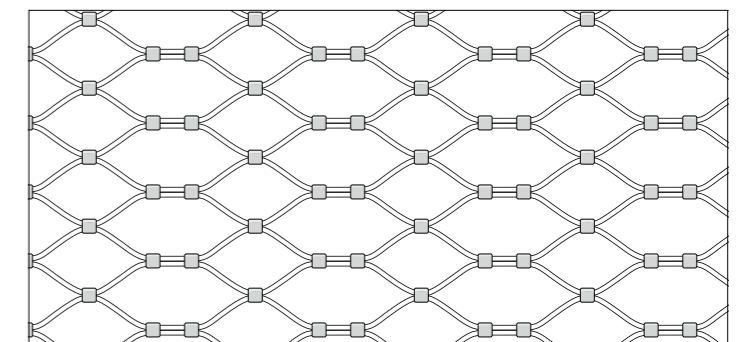
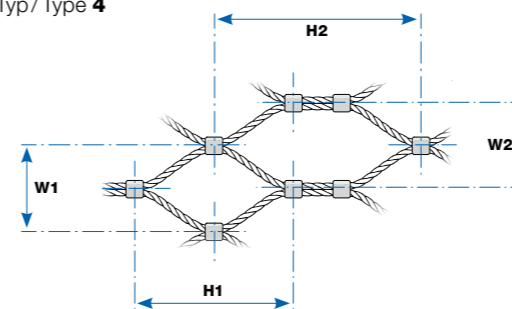

Typ/Type 5

